

**100MHz Current Feedback Amplifier**



The EL2120 is a wideband current feedback amplifier optimized for video performance. Its 0.01% differential gain and 0.03 degree differential phase performance when at  $\pm 5V$  supplies exceeds the performance of other amplifiers running on  $\pm 15V$  supplies. Operating on  $\pm 8$  to  $\pm 15V$  supplies reduces distortions to 0.01% and 0.01 degrees and below. The EL2120 can operate with supplies as low as  $\pm 2.5V$  or a single +5V supply.

Being a current feedback design, bandwidth is a relatively constant 100MHz over the  $\pm 1$  to  $\pm 10$  gain range. The EL2120 has been optimized for flat gain over frequency and all characteristics are maintained at positive unity gain. Because the input slew rate is similar to the 700V/ $\mu s$  output slew rate the part makes an excellent high-speed buffer.

The EL2120 has a superior output disable function. Time to enable or disable is 50ns and does not change markedly with temperature. Furthermore, in disable mode the output does not draw excessive currents when driven with 1000V/ $\mu s$  slew rates. The output appears as a 3pF load when disabled.

**Simplified Schematic**

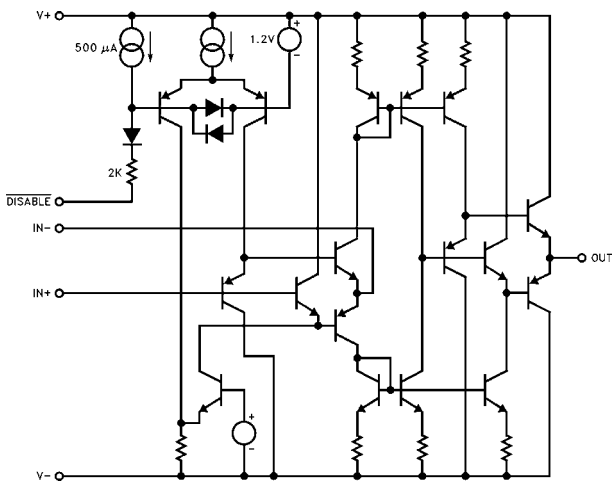

**Features**

- Excellent differential gain and phase on  $\pm 5V$  to  $\pm 15V$  supplies
- 100MHz -3dB bandwidth from gains of  $\pm 1$  to  $\pm 10$
- 700V/ $\mu s$  slew rate
- 0.1dB flatness to 20MHz
- Output disable in 50ns - remains high impedance even when driven with large slew rates
- Single +5V supply operation
- AC characteristics are lot and temperature stable
- Available in small SO-8 package

**Applications**

- Video gain block
- Residue amplifier
- Multiplexer
- Current to voltage converter
- Coax cable driver with gain of 2
- ADC driver

**Ordering Information**

PART NUMBER	TEMP. RANGE	PACKAGE	PKG. NO.
EL2120CN	0°C to +75°C	8-Pin PDIP	MDP0031
EL2120CS	0°C to +75°C	8-Pin SO	MDP0027

**Pinouts**

**EL2120  
(8-PIN PDIP)  
TOP VIEW**

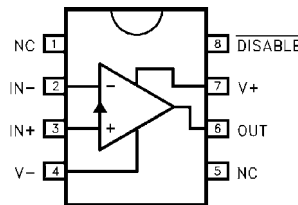

**EL2120  
(8-PIN SO)  
TOP VIEW**

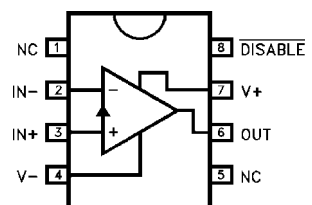

**Absolute Maximum Ratings** ( $T_A = 25^\circ\text{C}$ )

Voltage between V+ and V- . . . . .	.33V	Output Current . . . . .	$\pm 50\text{mA}$
Voltage at +IN, -IN, $V_{OUT}$ . . . . .	(V-) - 0.5V to (V+) + 0.5V	Internal Power Dissipation . . . . .	See Curves
Voltage between +IN and -IN . . . . .	$\pm 5\text{V}$	Operating Ambient Temperature Range . . . . .	$0^\circ$ to $75^\circ\text{C}$
Voltage at /Disable . . . . .	(V+) - 10V to (V+) + 0.5V	Operating Junction Temperature PDIP or SO . . . . .	$150^\circ\text{C}$
Current into +IN, -IN, and /Disable . . . . .	$\pm 5\text{mA}$	Storage Temperature Range . . . . .	$-65^\circ\text{C}$ to $+150^\circ\text{C}$

CAUTION: Stresses above those listed in "Absolute Maximum Ratings" may cause permanent damage to the device. This is a stress only rating and operation of the device at these or any other conditions above those indicated in the operational sections of this specification is not implied.

IMPORTANT NOTE: All parameters having Min/Max specifications are guaranteed. Typical values are for information purposes only. Unless otherwise noted, all tests are at the specified temperature and are pulsed tests, therefore:  $T_J = T_C = T_A$

**Open-Loop DC Electrical Specifications**

$V_S = \pm 5\text{V}$ ;  $R_L = 150\Omega$ ,  $T_A = 25^\circ\text{C}$  unless otherwise specified

PARAMETER	DESCRIPTION	TEMP	MIN	TYP	MAX	UNITS
V <sub>OS</sub>	Input Offset Voltage $V_S = \pm 15\text{V}$	Full		4	20	mV
		Full		2	25	mV
V <sub>OS/T</sub>	Input Offset Drift	Full		20		$\mu\text{V}/^\circ\text{C}$
I <sub>B+</sub>	+V <sub>IN</sub> Input Bias Current	Full		5	15	$\mu\text{A}$
I <sub>B-</sub>	-V <sub>IN</sub> Input Bias Current	Full		10	50	$\mu\text{A}$
CMRR	Common-Mode Rejection (Note 1)	Full	50	55		dB
-ICMR	-Input Current Common-Mode Rejection (Note 1)	Full		8	20	$\mu\text{A}/\text{V}$
PSRR	Power Supply Rejection (Note 2)	Full	65	80		dB
+IPSR	+Input Current Power Supply Rejection (Note 2)	$25^\circ\text{C}$		0.03		$\mu\text{A}/\text{V}$
-IPSR	-Input Current Power Supply Rejection (Note 2)	Full		0.6	5	$\mu\text{A}/\text{V}$
R <sub>OL</sub>	Transimpedance	Full	70	140		k $\Omega$
A <sub>VOL</sub>	Voltage Gain	Full	58	66		dB
+R <sub>IN</sub>	+V <sub>IN</sub> Input Impedance	$25^\circ\text{C}$		2		M $\Omega$
V <sub>IN</sub>	+V <sub>IN</sub> Range	Full	$\pm 3.0$	$\pm 3.5$		V
V <sub>O</sub>	Output Voltage Swing	Full	$\pm 3.0$	$\pm 3.5$		V
I <sub>SC</sub>	Output Short-Circuit Current	$25^\circ\text{C}$		100		mA
I <sub>O,DIS</sub>	Output Current, Disabled	Full		5	50	$\mu\text{A}$
V <sub>DIS,ON</sub>	Disable Pin Voltage for Output Enabled	Full	(V+) - 1			V
V <sub>DIS,OFF</sub>	Disable Pin Voltage for Output Disabled	Full			(V+) - 4	V
I <sub>DIS,ON</sub>	Disable Pin Current for Output Enabled	Full			5	$\mu\text{A}$
I <sub>DIS,OFF</sub>	Disable Pin Current for Output Disabled	Full	1.0			mA
I <sub>S</sub>	Supply Current ( $V_S = \pm 15\text{V}$ )	Full		17	20	mA

NOTES:

1. The input is moved from -3V to +3V
2. The supplies are moved from  $\pm 5\text{V}$  to  $\pm 15\text{V}$

**Closed-Loop AC Electrical Specifications**

$V_S = \pm 15V$ ;  $A_V = +2$  ( $R_F = R_G = 270\Omega$ );  $R_L = 150\Omega$ ;  $C_L = 7pF$ ;  $C_{IN-} = 2pF$ ;  $T_A = 25^\circ C$

PARAMETER	DESCRIPTION	MIN	TYP	MAX LEVEL	UNITS
SR	Slew Rate; $V_{OUT}$ from -3V to +3V Measured at -2V and +2V  $V_S = \pm 15V$ $V_S = \pm 5V$		750 550		V/ $\mu s$ V/ $\mu s$
$t_S$	Settling Time to 0.25% of a 0 to +10V Swing; $A_V = +1$ with $R_F = 270\Omega$ , $R_G = x$ , and $R_L = 400\Omega$		50		ns
BW	Bandwidth  -3dB $\pm 1dB$ $\pm 0.1dB$		95 50 16		MHz MHz MHz
BW@2.5V	Bandwidth at $V_S = \pm 2.5V$  -3dB $\pm 1dB$ $\pm 0.1dB$		75 35 11		MHz MHz MHz
Peaking			0.5		dB
dG	Differential Gain; DC Offset from -0.7V through +0.7V, AC Amplitude 286 mVp-p  $V_S = \pm 15V$ , $f = 3.58MHz$ $V_S = \pm 15V$ , $f = 30MHz$ $V_S = \pm 5V$ , $f = 3.58MHz$		<0.01 0.1 0.01		% % %
d $\theta$	Differential Phase; DC Offset from -0.7V through +0.7V, AC Amplitude 286 mVp-p  $V_S = \pm 15V$ , $f = 3.58MHz$ $V_S = \pm 15V$ , $f = 30MHz$ $V_S = \pm 5V$ , $f = 3.58MHz$		0.01 0.1 0.06		$^\circ$ $^\circ$ $^\circ$

**Typical Performance Curves**

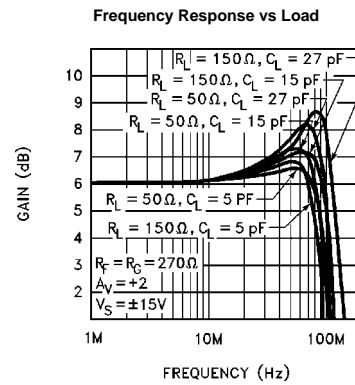
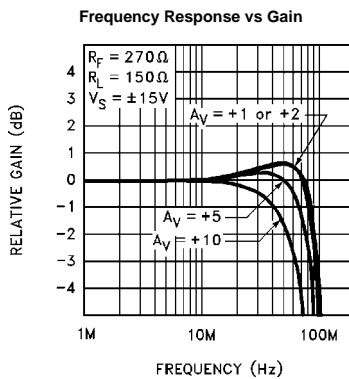
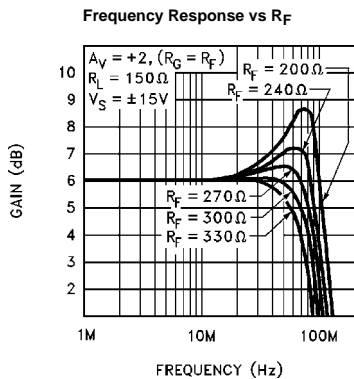
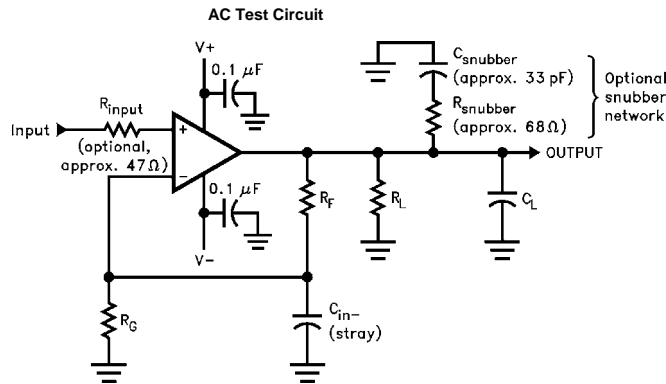

Typical Performance Curves (Continued)

Gain Flatness vs  $R_F$

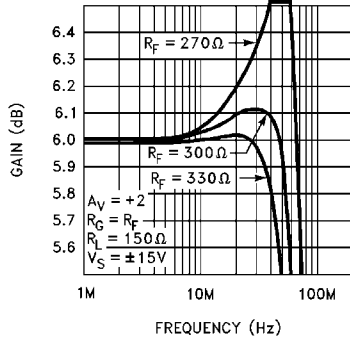

Gain Flatness vs  $C_{IN-}$

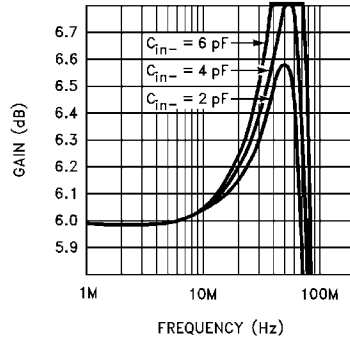

-3dB Bandwidth, 0.1dB Bandwidth, and Peaking vs Temperature at  $V_S \pm 15V$

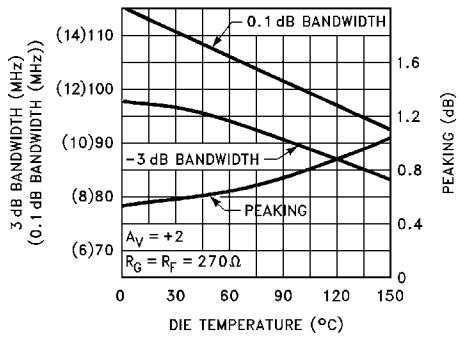

-3dB Bandwidth, 0.1dB Bandwidth, and Peaking vs Temperature at  $V_S \pm 5V$

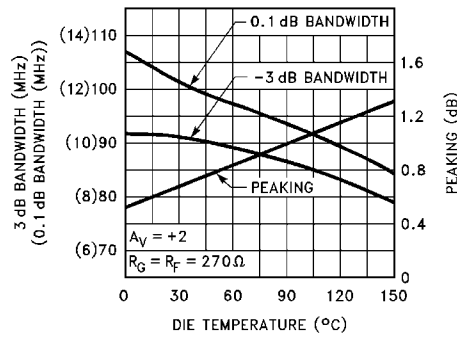

-3dB Bandwidth, 0.1dB Bandwidth, and Peaking vs Supply Voltage

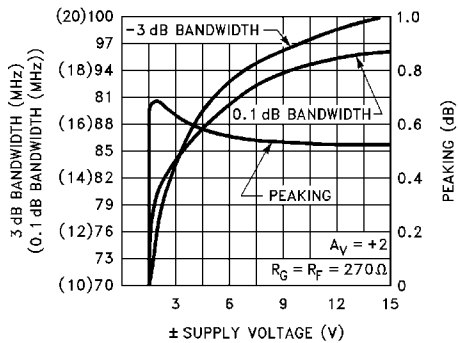

Deviation From Linear Phase vs Frequency

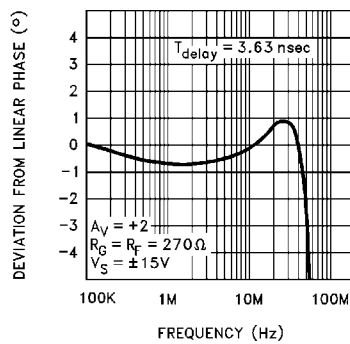

Typical Performance Curves (Continued)

Differential Gain vs  
DC Input Offset  
at 3.58MHz

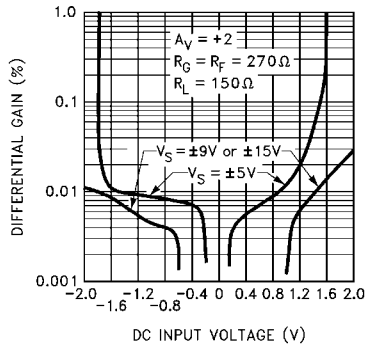

Differential Phase vs  
DC Input Offset  
at 3.58MHz

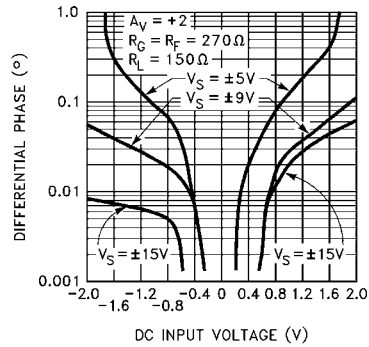

Differential Gain vs  
DC Input Offset  
at 30MHz

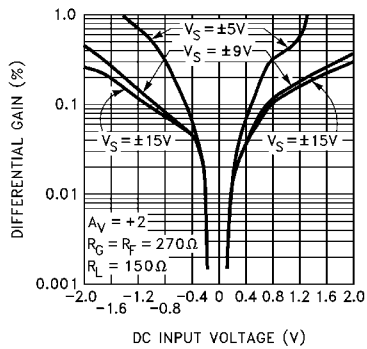

Differential Phase vs  
DC Input Offset  
at 30MHz

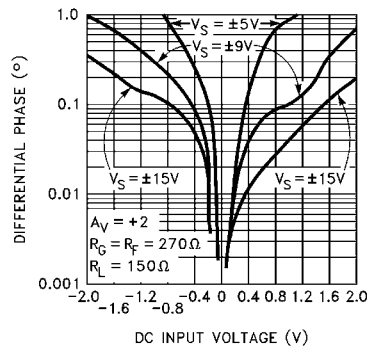

Differential Gain and Phase  
vs Supply Voltage  
(V\_IN, DC from 0 to +0.7V)

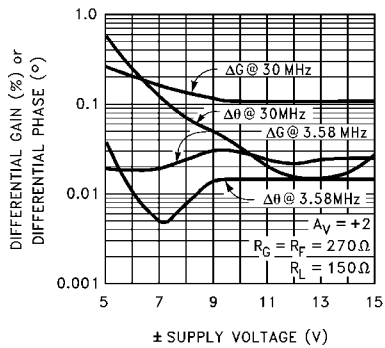

Input Noise Voltage  
and Current

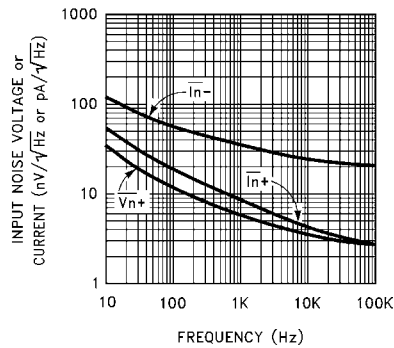

Typical Performance Curves (Continued)

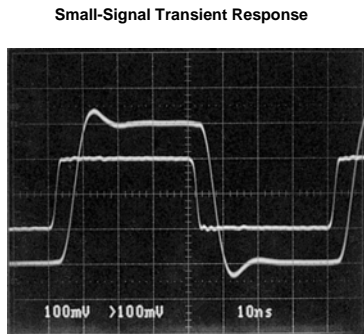
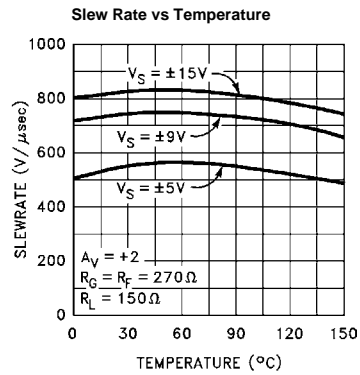
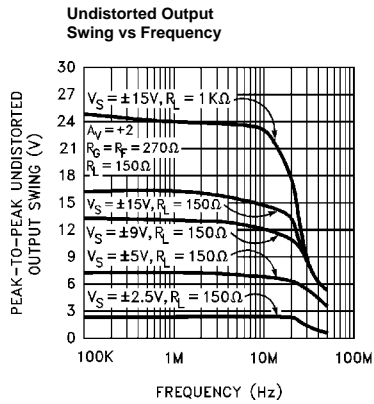

$A_V = +2, R_F = R_G = 270\Omega, R_L = 150\Omega$

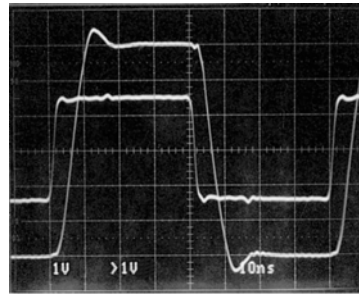

$A_V = +2, R_F = R_G = 270\Omega, R_L = 150\Omega, V_S = \pm 15V$

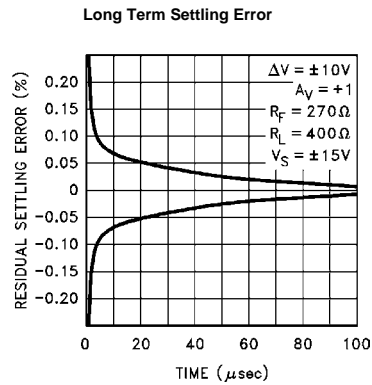
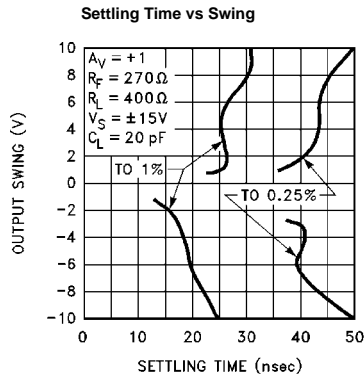

## Typical Performance Curves (Continued)

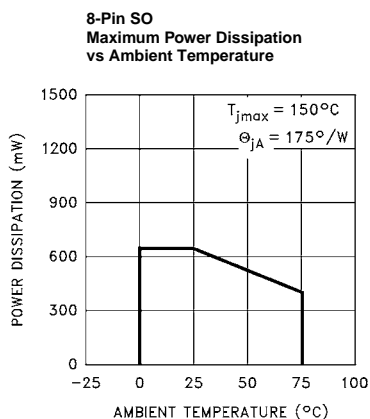
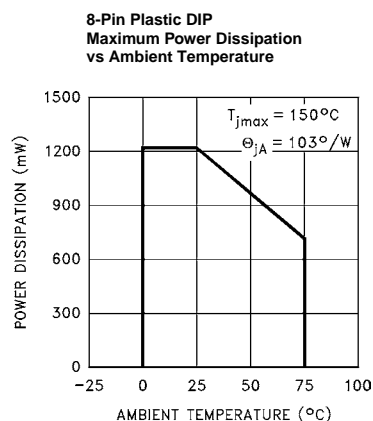
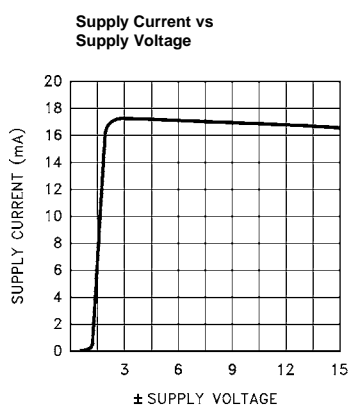
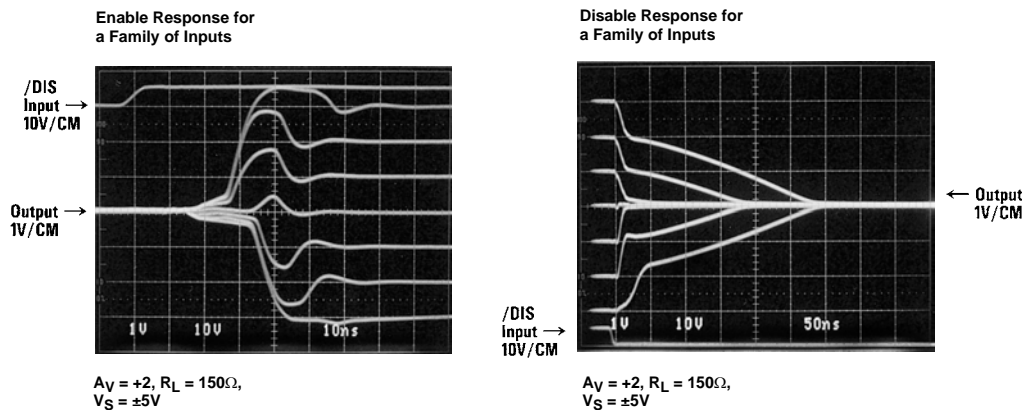

## Applications Information

The EL2120 represents the third generation of current-feedback amplifier design. It is designed to provide good high-frequency performance over wide supply voltage, load impedance, gain, temperature, and manufacturing lot variations. It is a well-behaved amplifier in spite of its 100MHz bandwidth, but a few precautions should be taken to obtain maximum performance.

The power supply pins must be well bypassed. 0.01 $\mu\text{F}$  ceramic capacitors are adequate, but lead length should be kept below 1/4" and a ground plane is recommended. Bypassing with 4.7 $\mu\text{F}$  tantalum capacitors can improve

settling characteristics, and smaller capacitors in parallel will not be needed. The lead length of sockets generally deteriorates the amplifier's frequency response by exaggerating peaking and increasing ringing in response to transients. Short sockets cause little degradation.

Load capacitance also increases ringing and peaking. Capacitance greater than 35pF should be isolated with a series resistor. Capacitance at the  $V_{IN-}$  terminal has a similar effect, and should be kept below 5pF. Often, the inductance of the leads of a load capacitance will be self-resonant at frequencies from 40MHz to 200MHz and can cause oscillations. A resonant load can be de-Q'ed with a small series or parallel resistor. A "snubber" can sometimes

be used to reduce resonances. This is a resistor and capacitor in series connected from output to ground. Values of 68Ω and 33pF are typical. Increasing the feedback resistor can also improve frequency flatness.

The  $V_{IN+}$  pin can oscillate in the 200MHz to 500MHz realm if presented with a resonant or inductive source impedance. A series 27Ω to 68Ω resistor right on the  $V_{IN+}$  pin will suppress such oscillations without affecting frequency response.

-3dB bandwidth is inversely proportional to the value of feedback resistor  $R_F$ . The EL2120 will tolerate values as low as 180Ω for a maximum bandwidth of about 140MHz, but peaking will increase and tolerance to stray capacitance will reduce. At gains greater than 5, -3dB bandwidth begins to reduce, and a smaller  $R_F$  can be used to maximize frequency response.

The greatest frequency response flatness (to 0.1dB, for instance) occurs with  $R_F = 300\Omega$  to 330Ω. Even the moderate peaking caused by lower values of  $R_F$  will cause the gain to peak out of the 0.1dB window, and higher values of  $R_F$  will cause an overcompensated response where the gain falls below the 0.1dB level. Parasitic capacitances will generally degrade the frequency flatness.

The EL2120 should not output a continuous current above 50mA, as stated in the ABSOLUTE MAXIMUM RATINGS table. The output current limit is set to 120mA at a die temperature of 25°C and reduces to 85mA at a die temperature of 150°C. This large current is needed to slew load capacitance and drive low impedance loads with low distortion but cannot be supported continuously. Furthermore, package dissipation capabilities cannot be met under short-circuit conditions. Current limit should not occur longer than a few seconds.

The output disable function of the EL2120 is optimized for video performance. While in disable mode, the feedthrough of the circuit can be modeled as a 0.2pF capacitor from  $V_{IN+}$  to the output. No more than ±5V can be placed between  $V_{IN+}$  and  $V_{IN-}$  in disable mode, but this is compatible with common video signal levels. In disabled state the output can withstand about 1000V/μs slew rate signals impressed on it without the output transistors turning on.

The /Disable pin logic level is referred to  $V_+$ . With ±5V supplies, a CMOS or TTL driver with pull-up resistor will suffice. ±15V supplies require a +14/+11V drive span, or +15/+10V nominally. Open-collector TTL with a tapped pull-up resistor can provide these spans. The impedance of the divider should be 1k or less for optimum enable/disable speed.

The EL2120 enables in 50ns or less. When  $V_{IN} = 0$ , only a small switching glitch occurs at the output. When  $V_{IN}$  is some other value, the output overshoots by about 0.7V when settling toward its new enabled value.

When the EL2120 disables, it turns off very rapidly for inputs of ±1V or less, and the output sags more slowly for inputs larger than this. For inputs as large as ±2.5V the output current can be absorbed by another EL2120 simultaneously enabled. Under these conditions, switching will be properly completed in 50ns or less.

The greater thermal resistance of the SO-8 package requires that the EL2120 be operated from ±10V supplies or less to maintain the 150°C maximum die temperature over the commercial temperature range. The P-DIP package allows the full ±16.5V supply operation.



Typical Applications Circuit—A High Quality Two-Input Multiplexer

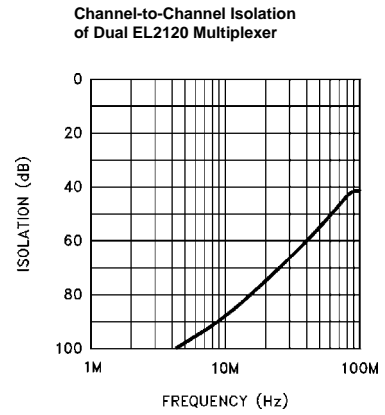
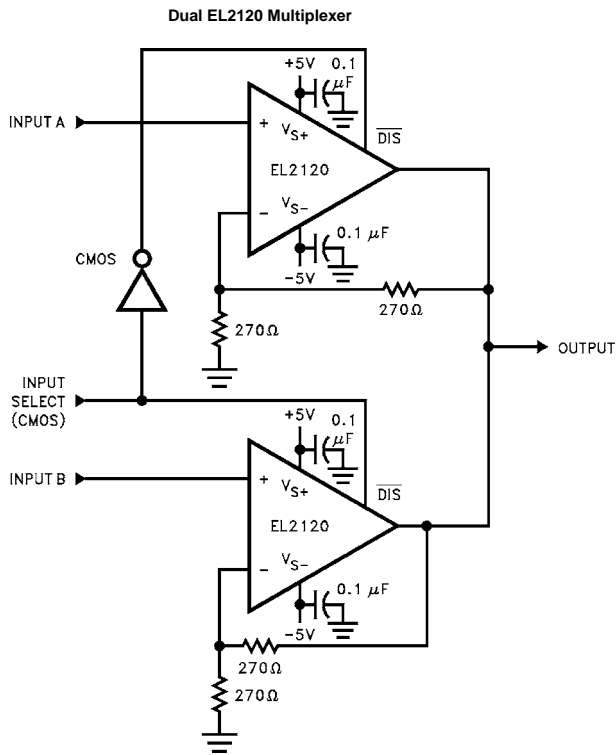

Dual EL2120 Multiplexer Switching Channels: Uncorrelated Sinewave Switched to a Family of DC Levels

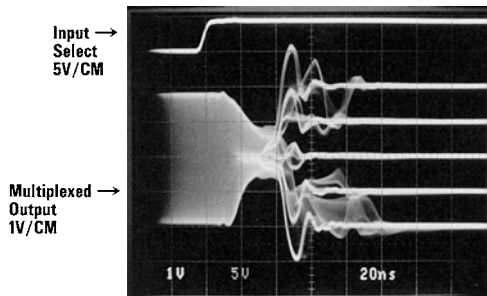

Dual EL2120 Multiplexer Switching Channels: a Family of DC Levels Switched to an Uncorrelated Sinewave

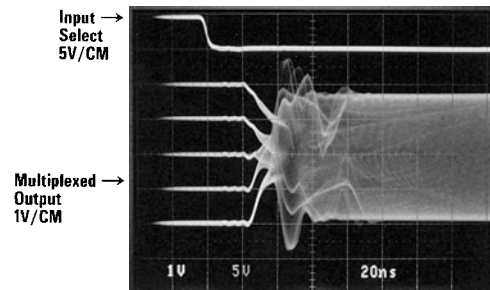

**The EL2120 Macromodel**

This macromodel has been developed to assist the user in simulating the EL2120 with surrounding circuitry. It was developed for the PSPICE simulator (copyrighted by the Microsim corporation), and may need to be rearranged for other simulators, particularly the H operator. It approximates frequency response and small-signal transients as well, although the effects of load capacitance does not show. This model is slightly more complicated than the models used for low-frequency op-amps, but is much more accurate for AC.

The model does not simulate these characteristics accurately:

- noise
- non-linearities
- slew rate limitations
- temperature effects
- settling time
- manufacturing variations
- input or output resonances
- CMRR and PSRR

\* Revision A. March 1992

\* Enhancements include PSRR, CMRR, and Slew Rate Limiting

\* Connections: +input

```

*      | -input
*      | | +Vsupply
*      | | | -Vsupply
*      | | | | output
*      | | | | |
.subckt M2120 3 2 7 4 6

```

\* Input Stage

```

*
e1 10 0 3 0 1.0
vis 10 9 0V
h2 9 12 vxx 1.0
r1 2 11 25
l1 11 12 20nH
iinp 3 0 10µA
iinm 2 0 5µA
r12 3 0 2Meg
*

```

\* Slew Rate Limiting

```

*
h1 13 0 vis 600
r2 13 14 1K
d1 14 0 dclamp
s2 0 14 dclamp
*

```

\* High Frequency Pole

```

*
e2 30 0 14 0 0.001666666666
l5 30 17 1µH
c5 17 0 0.5pF
r5 17 0 600
*

```

\* Transimpedance Stage

```

*
g1 0 18 17 0 1.0
rol 18 0 140K
cdp 18 0 7.9pF
*

```

\* Output Stage

```

*
q1 4 18 19 qp
q2 7 18 20 qn
q3 7 19 21 qn

```

```
q4 4 20 22 qp
r7 21 6 4
r8 22 6 4
ios1 7 19 2.5mA
ios2 20 4 2.5mA
*
* Supply
*
ips 7 4 10mA
*
* Error Terms
*
ivos 0 23 5mA
vxx 23 0 0V
e4 24 0 6 0 1.0
e5 25 0 7 0 1.0
e6 26 0 4 0 1.0
r9 24 23 562
r10 25 23 10K
r11 26 23 10K
*
* Models
*
.model qn npn (is=5e-15 bf=500 tf=0.1nS)
.model qp pnp (is=5e-15 bf=500 tf=0.1nS)
.model dclamp d(is=1e-30 ibv=0.02 bv=4 n =4)
.ends
```

The EL2120 Macromodel (Continued)

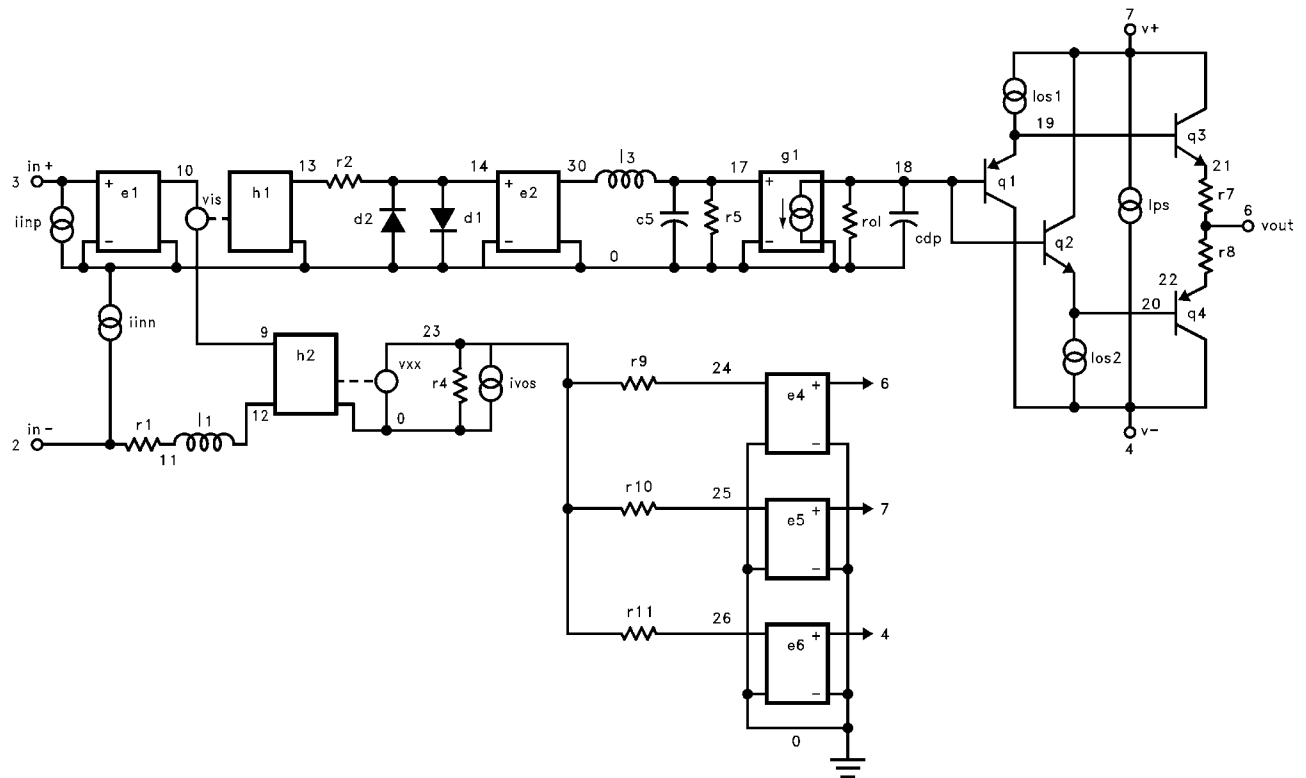

All Intersil U.S. products are manufactured, assembled and tested utilizing ISO9000 quality systems.  
 Intersil Corporation's quality certifications can be viewed at [www.intersil.com/design/quality](http://www.intersil.com/design/quality)

*Intersil products are sold by description only. Intersil Corporation reserves the right to make changes in circuit design, software and/or specifications at any time without notice. Accordingly, the reader is cautioned to verify that data sheets are current before placing orders. Information furnished by Intersil is believed to be accurate and reliable. However, no responsibility is assumed by Intersil or its subsidiaries for its use; nor for any infringements of patents or other rights of third parties which may result from its use. No license is granted by implication or otherwise under any patent or patent rights of Intersil or its subsidiaries.*

For information regarding Intersil Corporation and its products, see [www.intersil.com](http://www.intersil.com)